

RF 4-CH REMOTE

**4-Ch Hand
Remote**

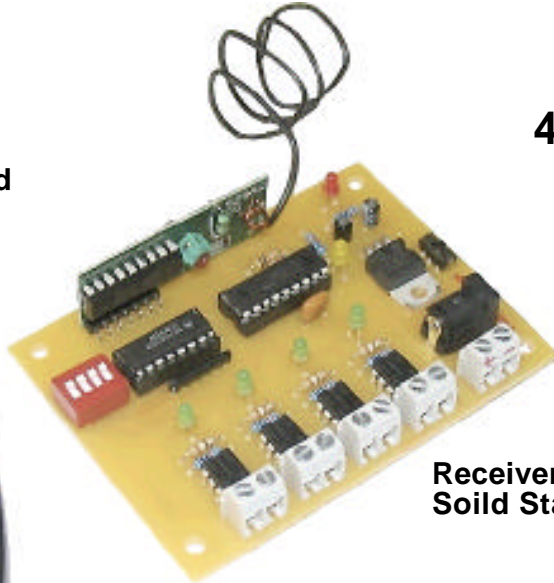

**4 - Channel RF Mini
Relay Module**



**Receiver Board with 4
Solid State Relays**

4 - Channel RF Mini Relay Module
Small RF relay board with 1 Amp Solid State Relays that can be set to latching and/or momentary mode.

Remote hand transmitter can activate each relay 1-4
On board dip switch sets each channel as latching or momentary.
Mixed mode latching and momentary can be done.

Hand Held Transmitter:
Type: RF radio(315MHz)
Transmitting Distance: 200m
Supply Power: 27A12V Battery
Encode: Fixed code
4 - Channel Soft Button
Extending Antenna (1-3/8" long)

Receiver Module:
Type: RF radio (315MHz)
Operating voltage: DC 9-12V
Decode: Fixed code
Relay: 1A - 12VDC

Hand Transmitter Size:
Approx 2-3/8"L x 1"W x 1/2"H

Receive, SS Relay Board Size:
Approx 3-3/4"L x 2-3/4"W x 1"H

Copyright © 2011 Blue Point Engineering, All Rights Reserved

Custom Equipment, Unique Electronic Products

Blue Point Engineering

Phone (303) 651-3794
www.BPEsolutions.com

RF 4-CH REMOTE

RF - 4 Channel Setup 2- Ch Servo Control

- A-B
- A-C
- B-C
- C-B

4-Ch RF Remote



RF 4Channel Receiver / SW Board

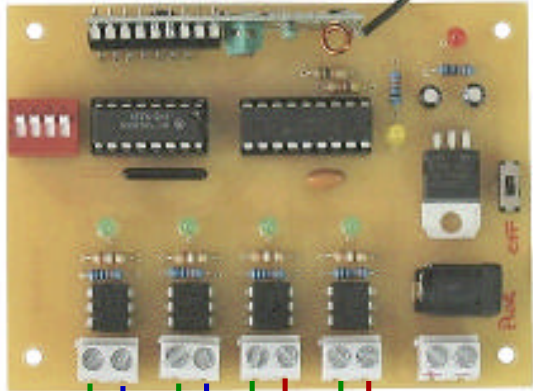

Start / Stop A-B or A-C or B-C / C-B

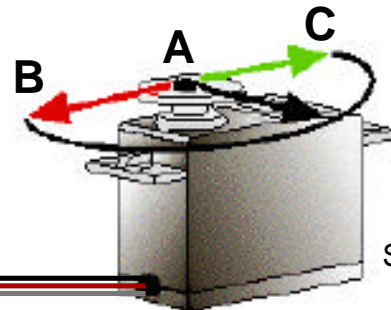

SERVO -1

Start / Stop A-B or A-C or B-C / C-B

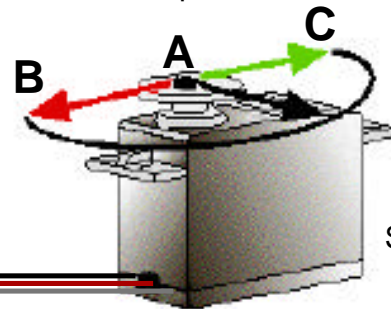

SERVO -2

2-Ch Servo Driver Board

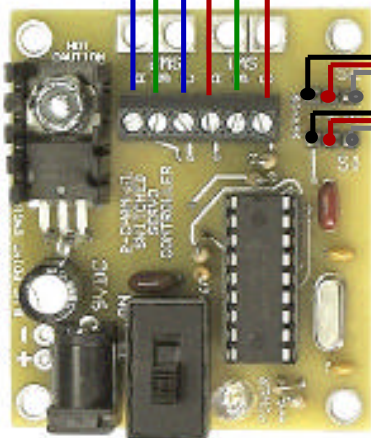

Servo Control

Copyright © 2011 Blue Point Engineering, All Rights Reserved

Custom Equipment, Unique Electronic Products

Blue Point Engineering

Phone (303) 651-3794
www.BPEsolutions.com

RF 4-CH REMOTE

RF - 4 Channel Setup
2- Ch Servo Control
B - A - C



4-Ch RF Remote

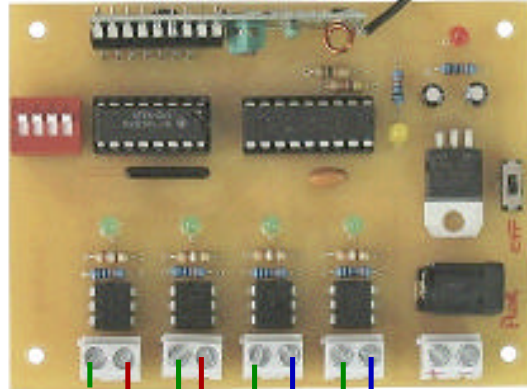

RF 4Channel Receiver / SW Board

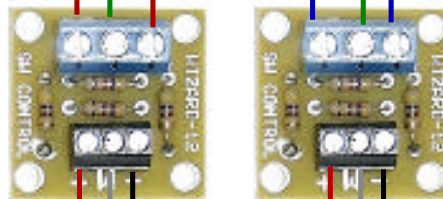

Wizard-12 Switch Adapter



Wizard-12 Controller Board



Start A to B Stop
Start A to C Stop
Start B to C Stop
Start C to B Stop

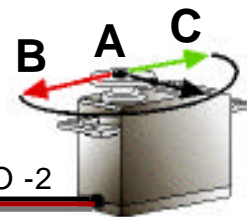

SERVO - 2

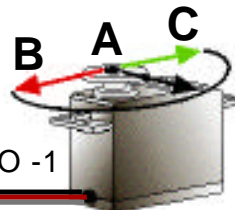

SERVO - 1

Start A to B Stop
Start A to C Stop
Start B to C Stop
Start C to B Stop

RF 4-CH REMOTE

RF - 4 Channel Setup 4 Ch LED Control

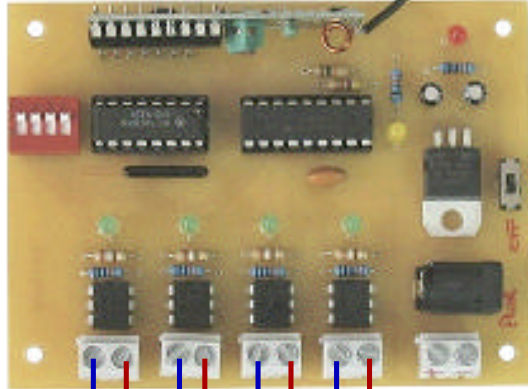

4-Ch RF Remote



RF 4Channel Receiver / SW Board

LED Power Supply

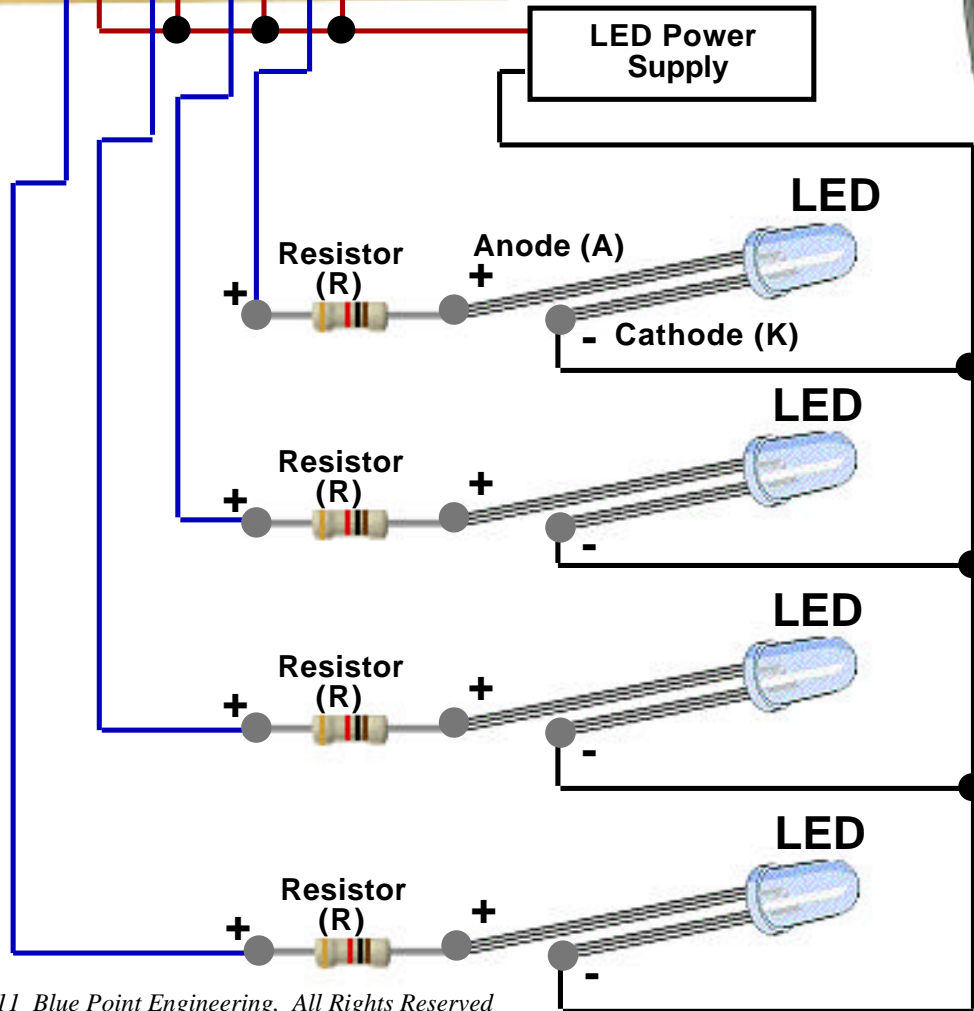

Copyright © 2011 Blue Point Engineering, All Rights Reserved

Custom Equipment, Unique Electronic Products

Blue Point Engineering

Phone (303) 651-3794
www.BPEsolutions.com

RF 4-CH REMOTE

RF - 4 Channel Setup 4 Ch LED Control



4-Ch RF Remote

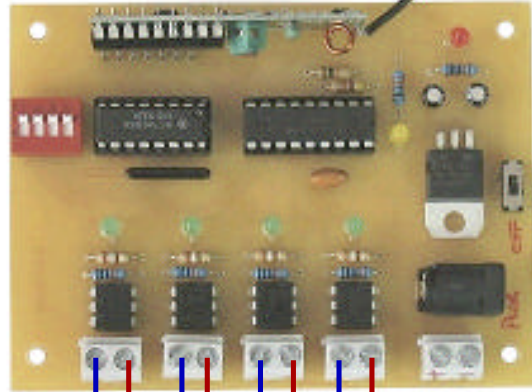

RF 4Channel Receiver / SW Board

LED STRIP

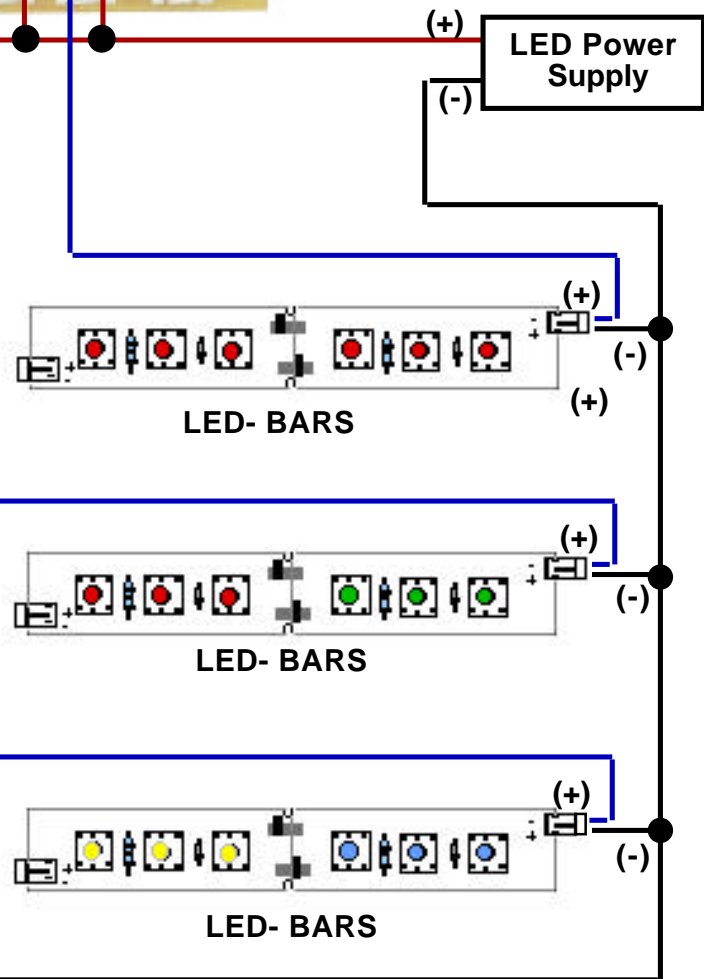

Copyright © 2011 Blue Point Engineering, All Rights Reserved

Custom Equipment, Unique Electronic Products

Blue Point Engineering

Phone (303) 651-3794
www.BPEsolutions.com

RF 4-CH REMOTE

RF - 4 Channel Setup
 2 Ch Servo Control
 1 Ch Sound Playback

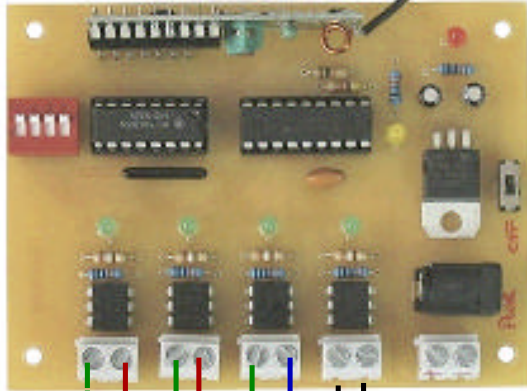

RF 4Channel Receiver / SW Board

SD Drive - MP3 Playback Board



Wizard-12 Switch Adapter

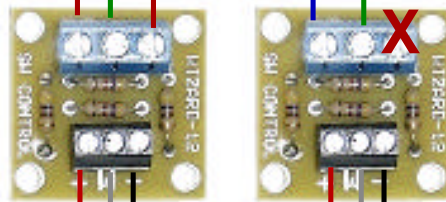

Wizard-12 Controller Board

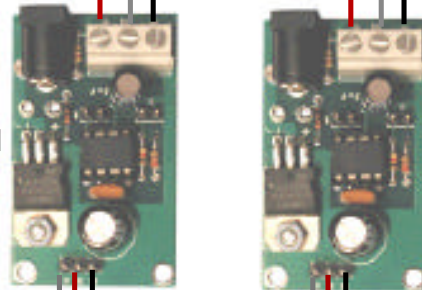

- OR -

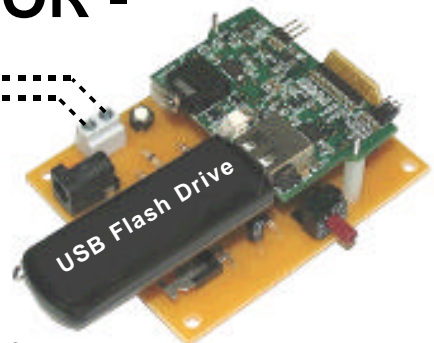

Start A to B Stop
 Start A to C Stop
 Start B to C Stop
 Start C to B Stop

Start A to B Stop
 Start B to A Stop

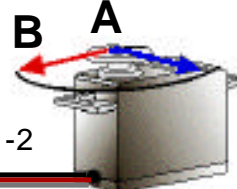

Copyright © 2011 Blue Point Engineering, All Rights Reserved

Custom Equipment, Unique Electronic Products

Blue Point Engineering

Phone (303) 651-3794
 www.BPEsolutions.com